

**ANNEXURE-XIII
INSTRUCTION FOR USE
(TLF/LML/004)**

IFU No.	: IFU/LML/004A
Date	: 26/08/2023
Revision No.	: 08

1.0 INSTRUCTION FOR USE:

- 1.1 PRODUCT FAMILY: Sterile Hypodermic Safety Syringe - clip type with/without needles:** (1mL, 2mL, 2.5mL, 3mL, 5mL, 10mL and 20mL) with needle sizes (16G, 18G, 19G, 20G, 21G, 22G, 23G, 24G, 25G, 26G, 27G, 28G, 29G & 30G).
- 1.2 BASIC UDI:** 890615878LML004M2
- 1.3 MATERIAL USED:** Polypropylene, Thermoplastic Elastomer and Stainless Steel (304).
- 1.4 DEVICE DESCRIPTION:** A Safety syringe (Clip Type), is a simply consisting of a plunger/piston & gasket that's fits tightly within a cylindrical tube called a barrel. The piston can be linearly pulled and pushed along the inside of the tube/barrel, allowing the syringe to take-in and expel liquid or gas through a discharge orifice/nozzle/barrel tip at the front (open) end of the tube/barrel. The open end of the syringe may be fitted with a hypodermic needle, a nozzle or tubing to help direct the flow into and out of the barrel.
- After administration of the drugs (contents) through safety syringe, the Re-use prevention (RUP) feature (clip over the needle) to be activated manually, or as shown it's IFU, to prevent the needle stick injury.
- 1.5 INTENDED USE:** - Sterile hypodermic safety syringes for single use-clip type- with & without needle is intended for medical purposes to inject fluids into or withdraw fluids from the body. Sterile hypodermic safety syringes for single use-clip type- with & without needle used for all individuals (newborn to adults to old age), for administrations of injections or medicinal fluids. The device shall be used by qualified trained medical staff.
- 1.6 INDICATION FOR USE:** - Sterile hypodermic safety syringe for single use- clip type- with & without needle is intended to be used for medical purpose to inject fluids into or withdraw fluids from the body. After injection, the anti-needle stick feature is manually activated to aid in the prevention of accidental needle stick injuries.
- 1.7 INTENDED USER:** Sterile hypodermic safety syringes for single use- clip type with & without needle, to be used for all individuals (newborn to adults to old age) needs administrations of injections or medicinal fluids. The medical device shall be used by qualified trained medical staff, such as Doctor/Registered Practitioner or Paramedical staff.
- 1.8 PATIENT POPULATION:** Sterile hypodermic safety syringes for single use- clip type with & without needle, can be used for all individuals; (newborn to adults to old age) needs administrations of injections or medicinal fluids. The medical device shall be used by qualified and trained medical staff. The selection of hypodermic single use safety syringes for usage on

**ANNEXURE-XIII
INSTRUCTION FOR USE
(TLF/LML/004)**

patients is dependent on combination of patient age, physical condition and medication requirements.

1.9 CONTRAINDICATIONS:

- 1.9.1 Device must not be used other than as indicated in intended use.
- 1.9.2 Device should not be used for administration of blood and blood components.
- 1.9.3 Device should not be used for large volume fluids and fluids derivatives.
- 1.9.4 Device should not be used for administration of high viscous fluids.
- 1.9.5 Device should not be used on patients with known hypersensitive to device material.

1.10  CAUTION:

- 1.10.1 Device is single use only.
- 1.10.2 Device must not be reused. Reuse of the device may cause serious infection, cross contamination, transmission of bacteria, viruses and blood related transfusion of serious diseases.
- 1.10.3 Ensure before use that device/packing is not tempered or damage.
- 1.10.4 Device for manual use only.

1.11 DISCLAIMER:

- 1.11.1 The Medical device is supplied with limited functionality, Lifelong Meditech does not warrant any foreseeable risk resulting from improper/ misuse of the medical device.
- 1.11.2 Device should not be used out of its indications/instructions for use. In-case the device is used out of its instructions described, the manufacturer/supplier must be informed for any usage outside of its recommendations.

1.12 INSTRUCTION FOR USE:

- 1.12.1 Inspect package for integrity, expiry and then remove the syringe from unit package.
- 1.12.2 Be careful to pull the needle cap straight off to avoid the needle point damage.
- 1.12.3 Push and twist the needle clock wise on the syringe tip to seal it firmly and ensure a tight fitting.
- 1.12.4 Take the medicinal fluids.
- 1.12.5 Expel the air bubble through open end before injection.
- 1.12.6 To avoid the re-use and needle stick injury, the product should be used under the following steps:

**ANNEXURE-XIII
INSTRUCTION FOR USE
(TLF/LML/004)**

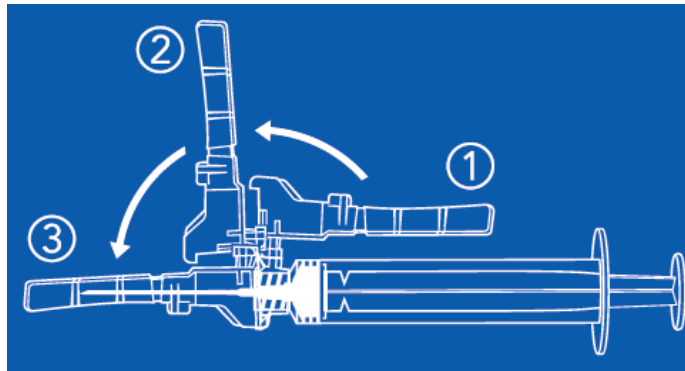

1.12.7 After usage of safety syringe, healthcare person manually cover the used needle with safety clip as shown in above image, to prevent the re-use of syringe and needle stick injury.

1.12.8 Device is single use only. Do not re-sterile. Syringe should be discarded after one procedure. It's extremely difficult to clean exactly after being expressed to biological materials and may causes adverse patient reactions if reuse, the cleaning of these devices may alter their structural property accordingly. Lifelong Meditech will not be responsible for direct incidental and consecution damages resulting for reuse.

1.13 STORAGE OF THE DEVICE: Store in cool and dry place. Note: Avoid exposure to direct sunlight.

1.14 SELF LIFE OF THE DEVICE: 05 Years from the manufacturing date.

1.15 DISPOSAL METHOD: Used medical device is considered as biohazard waste. Dispose-off the used medical device in accordance with hospital, administrative and/or local government policy.

1.16 ADVERSE EVENT: The device is supplied with limited functionality, and there is no foreseeable risk associated with the device usage. Consequences from the improper use may cause or lead to redness, swelling, bruising etc.





















1.17 For any feedback or query, customer/user can write or reach to us at:

Email- lmicustomer@lifelongindia.com **or** Customer Care No: +91-124-4406600



1.18 LABEL INFORMATIONS:

Symbol	Description
R_x Only	Device to be sale on order/prescription of a Physician /Doctor/ Paramedical staff only
REF	Catalogue number
LOT	Lot number: Batch number

**ANNEXURE-XIII
INSTRUCTION FOR USE
(TLF/LML/004)**

	Expiry date: Device can be used until the end of the month indicated
	Sterilization with ethylene oxide gas
	single use only
	Manufacturer
	Caution
	Conformité Européenne (CE marking is a mandatory conformity marking for certain devices sold within the European Economic Area)
	Do not re-sterilize
	Non pyrogenic
	Do not use, if package is damaged
	Keep dry
	Keep away from sunlight
	Date of manufacturing
	Authorized Representative in the European Community
	Consult instruction for use
	Reuse prevention (Applicable for safety syringe only)
	Safe disposal of syringe
	Do not use hook
	Store and stack in upright condition
	Fragile, handle with care
	Unique device identifier

**ANNEXURE-XIII
INSTRUCTION FOR USE
(TLF/LML/004)**

	Single sterile barrier system (For primary package only)
	Medical device
	Country of manufacture

 **Lifelong Meditech Private Limited,**
Plot No. 18, Sector – 5, IMT Manesar,
Gurgaon – 122050, Haryana (INDIA),
Mfg. License No. MFG/MD/2019/000203
lmcustomer@lifelongindia.com
Customer Care No: +91-124-4406600

 **MED DEVICES LIFESCIENCES
B.V.**
Keizersgracht 482 1017 EG Amsterdam,
The Netherlands
Tel : +31 202254558
Email: info@meddevices.net